

Roll-up - System 31

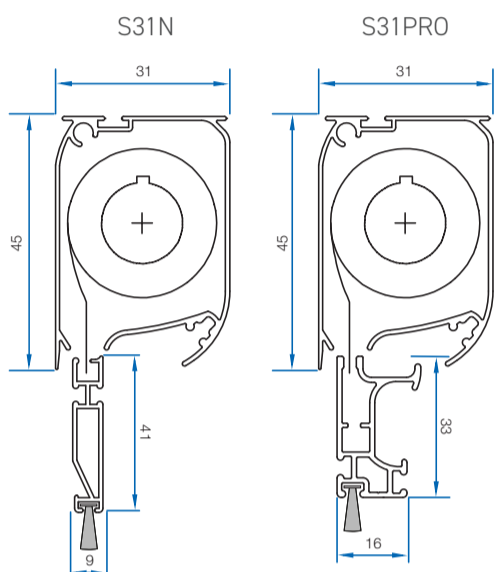

VERTICAL VERSION ONLY

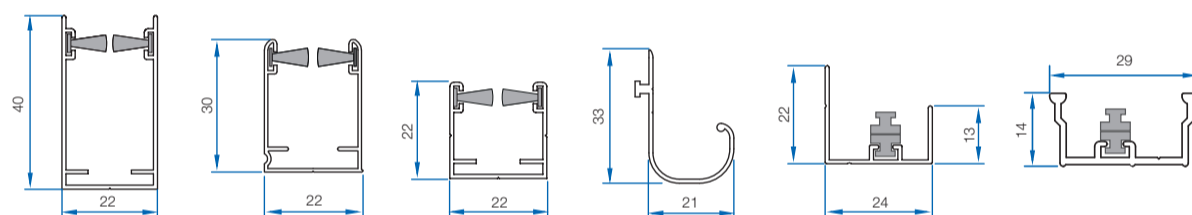

Max dimensions in mm

standar high trasparency mesh

| Vertical window | |
|-----------------|----------|
| Width | 500/1500 |
| Height | 500/1700 |

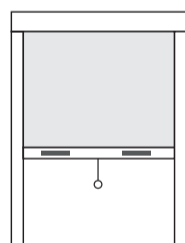

| Single roll-aside | |
|-------------------|------------|
| Width | 400/1300 |
| Height | 1000/2400* |

* 2600 with reinforcing profile added

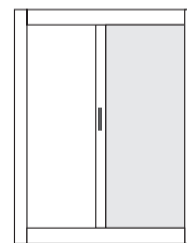

| Double roll-aside | |
|-------------------|------------|
| Width | 1000/2600 |
| Height | 1000/2400* |

* 2600 with reinforcing profile added

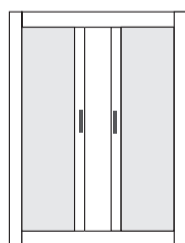

OPTIONS

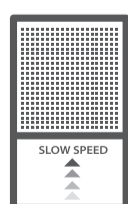

- Brake-Speed reducer
- Frein viscodynamique
- Bremse - Verlangamer
- Desacelerador viscodinámico

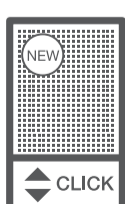

- Click-Stop
- Click-Stop
- Click-Stop
- Click-Stop

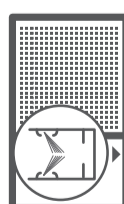

- Anti-Wind brushpile
- Brosse anti-vent
- Windschutzbürste
- Felpudo antiviento

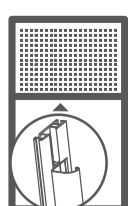

- Reinforcing profile
- Profil de renfort
- Verstärkungsprofile
- Perfil de refuerzo



- OVO-LOCK
- OVO-LOCK
- OVO-LOCK
- OVO-LOCK

Roll-up - System 33

S33

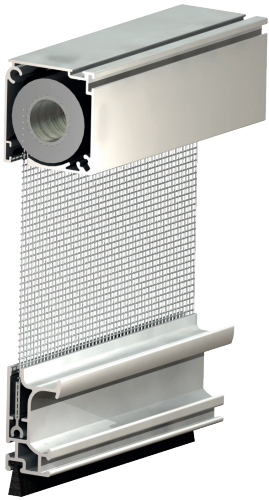

S33

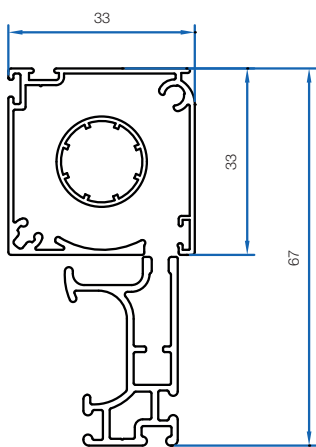

Inset Mount

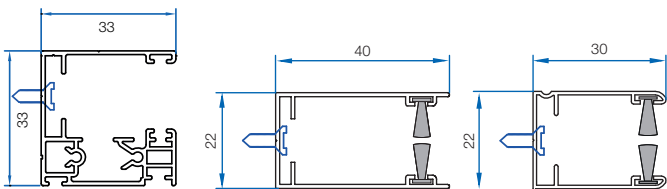

Face Mount

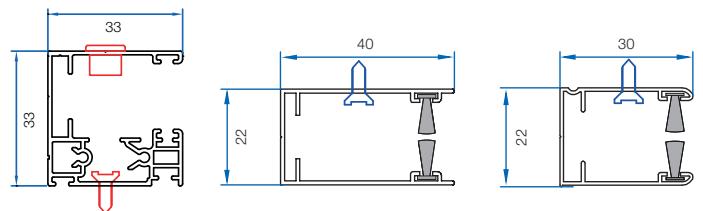

Max dimensions in mm

standar high trasparency mesh

| Vertical window | |
|-----------------|------|
| Width | 1600 |
| Height | 1700 |

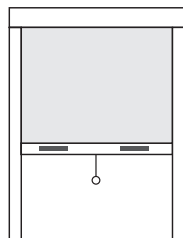

OPTIONS

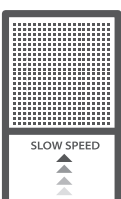

- Brake-Speed reducer
- Frein viscodynamique
- Bremse - Verlangsamer
- Desacelerador viscodinámico



- Anti-Wind brushpile
- Brosse anti-vent
- Windschutzbürste
- Felpudo antiviento

Roll-up - System 36

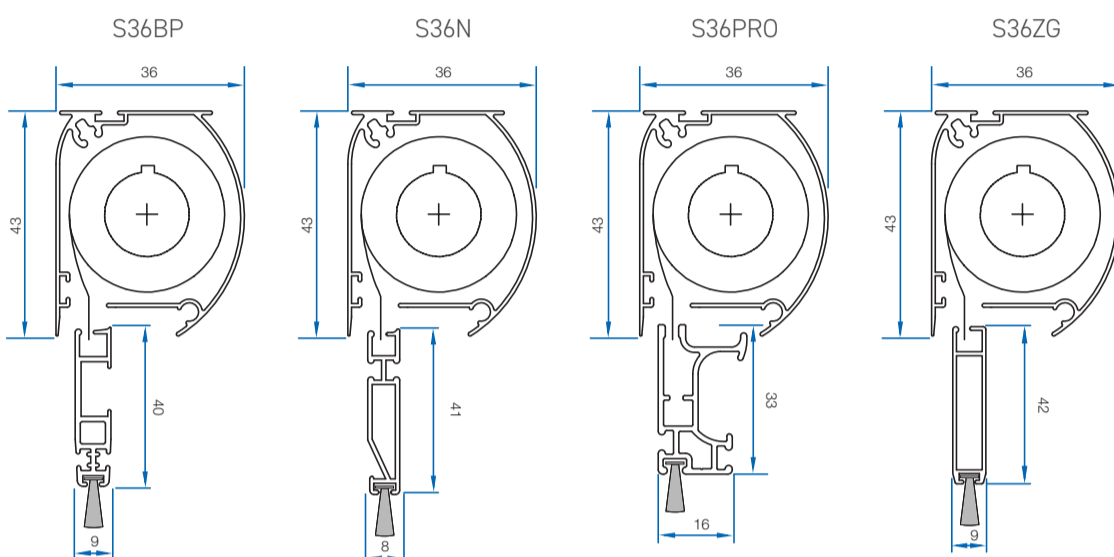

VERTICAL VERSION ONLY CHAIN AND MOTORIZED VERSION ONLY

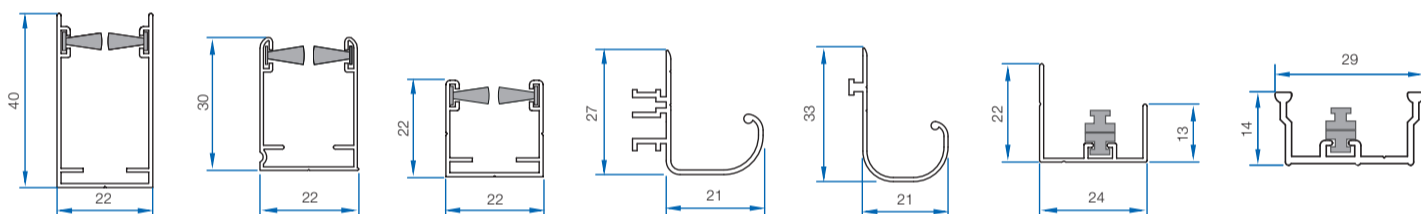

Max dimensions in mm

standard mesh fiberglass 18x16

| Vertical window | |
|-----------------|-----------|
| Width | 500/1500 |
| Height | 500/2400* |

*only with high transparency mesh

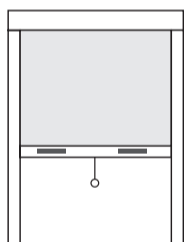

| Single roll-aside | |
|-------------------|-------------|
| Width | 400/1500 |
| Height | 1000/2400** |

** 2600 with reinforcing profile added

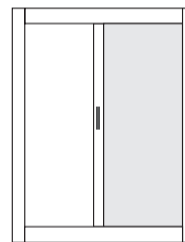

| ZG | |
|--------|----------|
| Width | 600/1500 |
| Height | 500/2400 |

*only with high transparency mesh

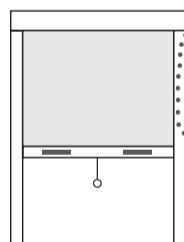

| Double roll-aside | |
|-------------------|-------------|
| Width | 1000/2600 |
| Height | 1000/2400** |

** 2600 with reinforcing profile added

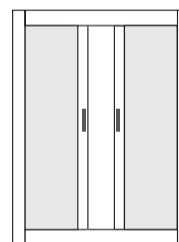

Optional meshes available for S.36

| Type | Max Height possible |
|---------------------------|---------------------|
| High transparency mesh | 240 cm |
| Solar shading Microscreen | 135 cm |
| Blackout Trigras | 140 cm |

OPTIONS

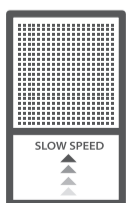

- Brake-Speed reducer
- Frein viscodynamique
- Bremse - Verlangsamer
- Desacelerador viscodinámico

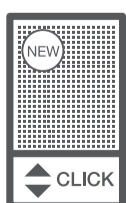

- Click-Stop
- Click-Stop
- Click-Stop
- Click-Stop



- Anti-Wind brushpile
- Brosse anti-vent
- Windschutzbürste
- Felpudo antiviento

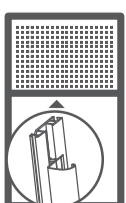

- Reinforcing profile
- Profil de renfort
- Verstärkungsprofile
- Perfil de refuerzo



- OVO-LOCK
- OVO-LOCK
- OVO-LOCK
- OVO-LOCK

Roll-up - System 41

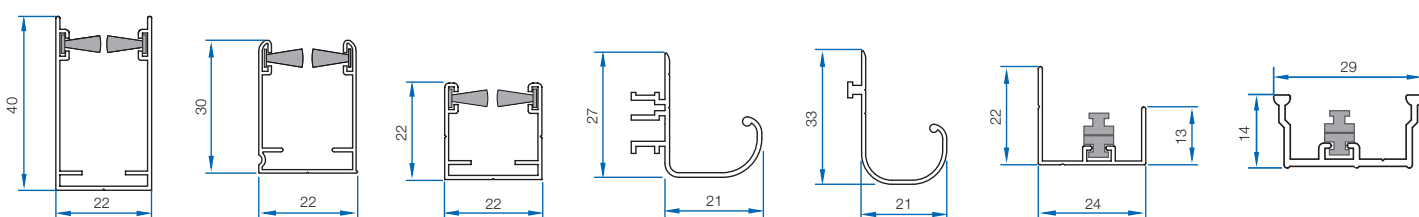
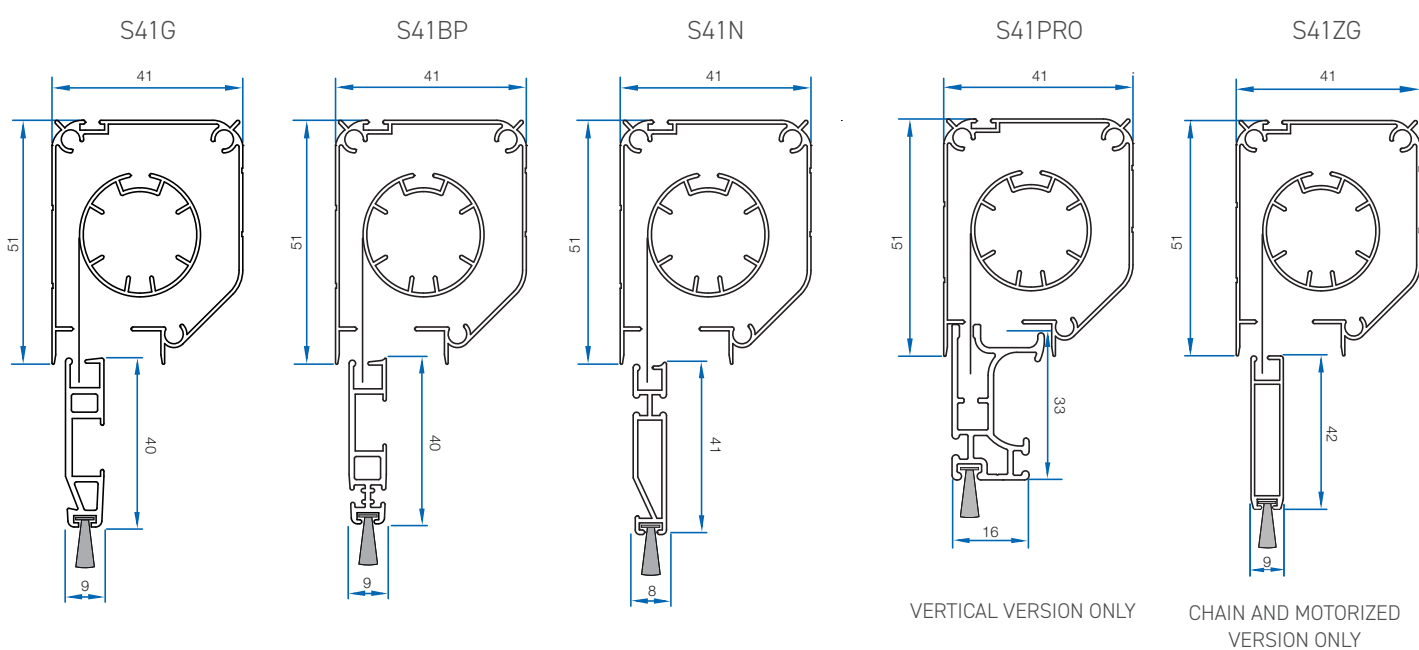

Max dimensions in mm

standard mesh fiberglass 18x16

| Vertical window | |
|-----------------|-----------|
| Width | 500/2000* |
| Height | 500/2600 |

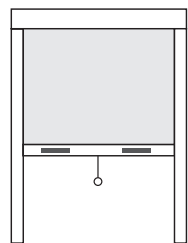

* 2300 with reinforcing profile added to pull-bar

| Single roll-aside | |
|-------------------|-------------|
| Width | 400/1500 |
| Height | 1000/2600** |

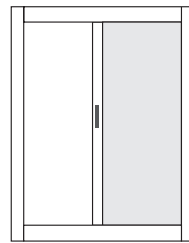

** 2900 with reinforcing profile added

| ZG | |
|--------|----------|
| Width | 600/1800 |
| Height | 500/2600 |

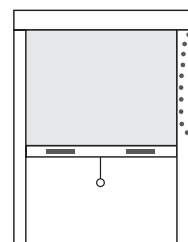

| Double roll-aside | |
|-------------------|-------------|
| Width | 1000/3000 |
| Height | 1000/2600** |

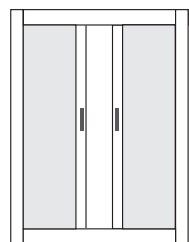

** 2900 with reinforcing profile added

| Optional meshes available for S.41 | |
|------------------------------------|---------------------|
| Type | Max Height possible |
| High transparency mesh | 260 cm |
| High resistance mesh | 140 cm |
| 20x20 mesh | 170 cm |
| 20x30 mesh | 170 cm |
| Antipollen net | 220 cm |
| Solar shading Microscreen | 160 cm |
| Blackout Trigras | 160 cm |

OPTIONS

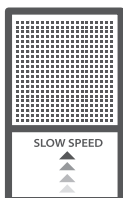

- Brake-Speed reducer
- Frein viscodynamique
- Bremse - Verlangsamert
- Desacelerador viscodinámico

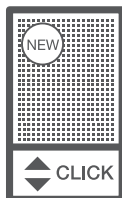

- Click-Stop
- Click-Stop
- Click-Stop
- Click-Stop



- Anti-Wind brushpile
- Brosse anti-vent
- Windschutzbürste
- Felpudo antiviento

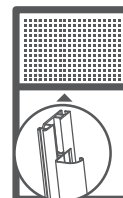

- Reinforcing profile
- Profil de renfort
- Verstärkungsprofile
- Perfil de refuerzo



- Lithium battery Motor
- Moteur Accu Lithium
- Lithium Motor
- Motor con batería al litio



- OVO-LOCK
- OVO-LOCK
- OVO-LOCK
- OVO-LOCK

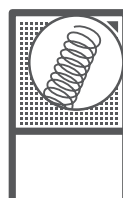

- STC spring tension control
- STC Réglage de la tension du ressort
- STC Federspannungskontrolle
- Control de tensión del muelle STC spring

Roll-up - System 43

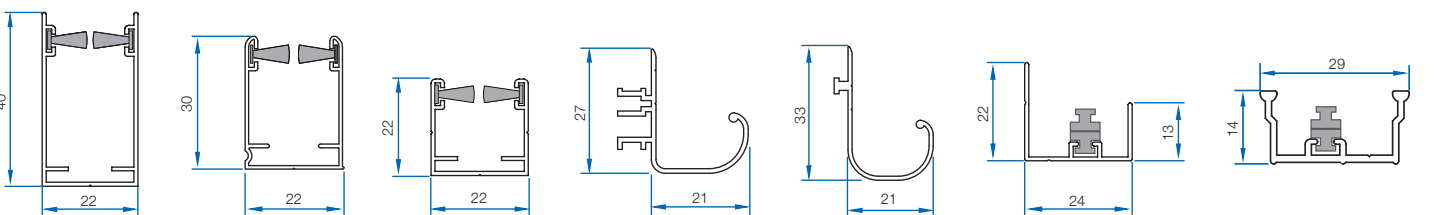
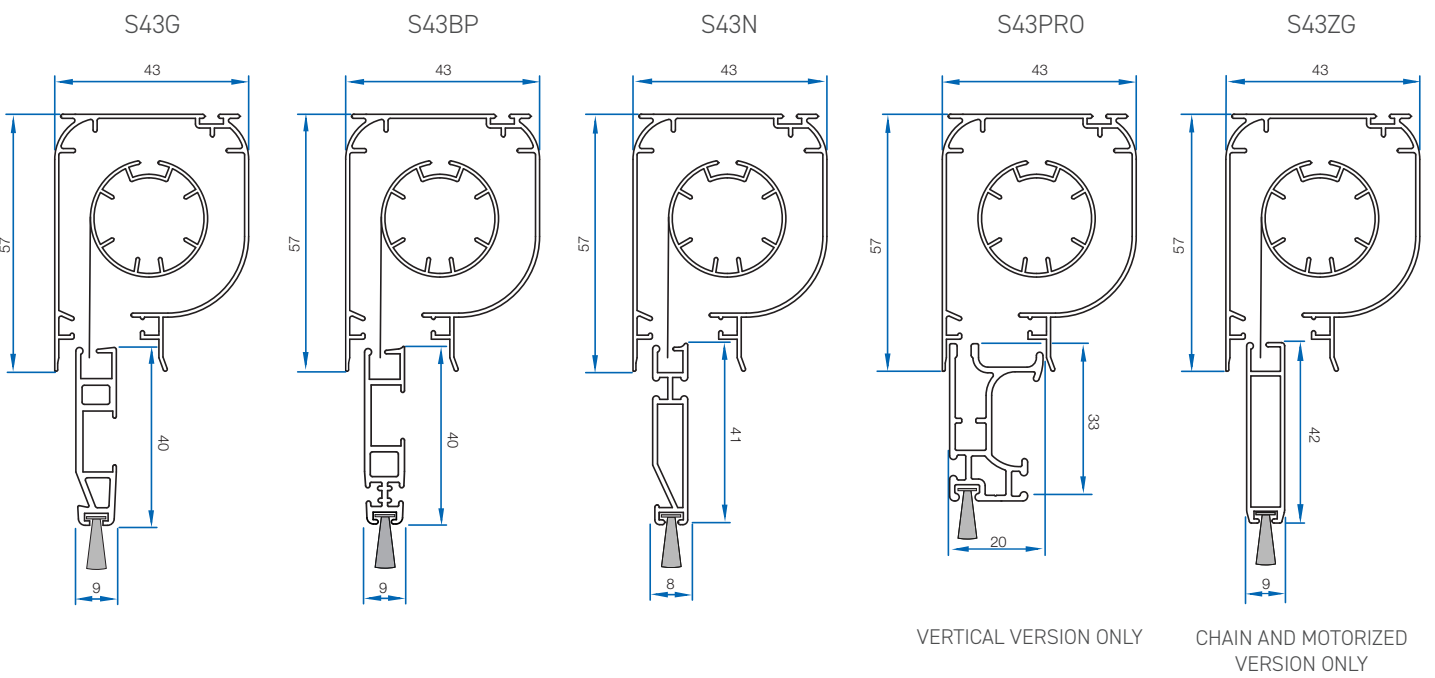
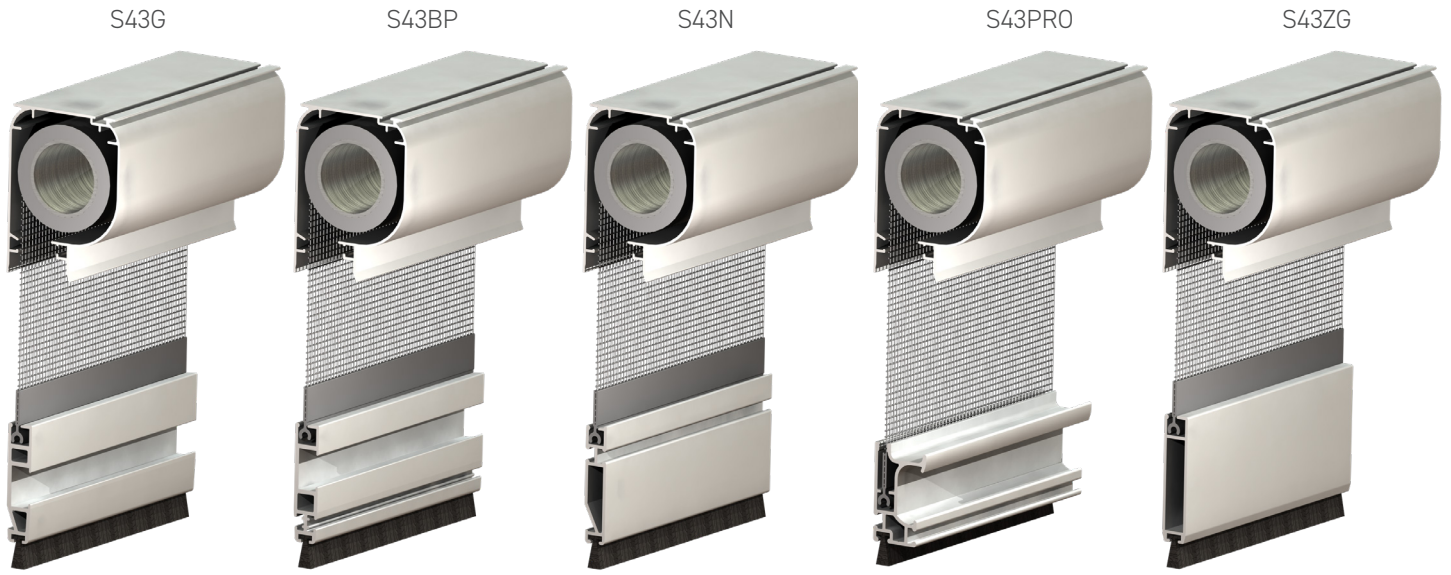

Max dimensions in mm

standard mesh fiberglass 18x16

| Vertical window | |
|-----------------|-----------|
| Width | 500/2000* |
| Height | 500/2600 |

* 2300 with reinforcing profile added to pull-bar

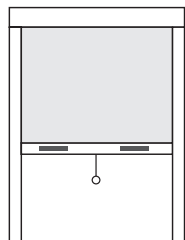

| Single roll-aside | |
|-------------------|-------------|
| Width | 400/1500 |
| Height | 1000/2600** |

** 2900 with reinforcing profile added

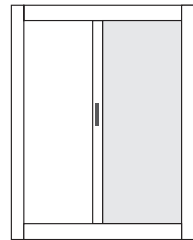

| ZG | |
|--------|----------|
| Width | 600/1800 |
| Height | 500/2600 |

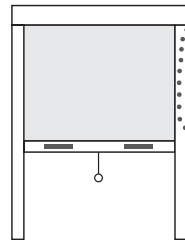

| Double roll-aside | |
|-------------------|-------------|
| Width | 1000/3000 |
| Height | 1000/2600** |

** 2900 with reinforcing profile added

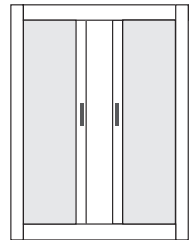

| Optional meshes available for S.43 | | |
|------------------------------------|---------------------|--|
| Type | Max Height possible | |
| High transparency mesh | 260 cm | |
| High resistance mesh | 160 cm | |
| 20x20 mesh | 183 cm | |
| 20x30 mesh | 183 cm | |
| Antipollen net | 220 cm | |
| Solar shading Microscreen | 195 cm | |
| Blackout Trigras | 195 cm | |

OPTIONS

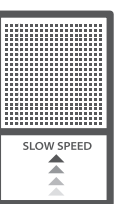

- Brake-Speed reducer
- Frein viscodynamique
- Bremse - Verlangsamter
- Desacelerador viscodinámico

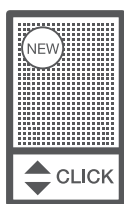

- Click-Stop
- Click-Stop
- Click-Stop
- Click-Stop

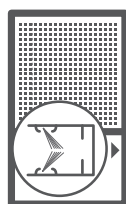

- Anti-Wind brushpile
- Brosse anti-vent
- Windschutzbürste
- Felpudo antiviento

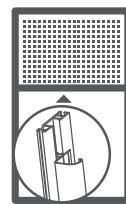

- Reinforcing profile
- Profil de renfort
- Verstärkungsprofil
- Perfil de refuerzo



- Lithium battery Motor
- Moteur Accu Lithium
- Lithium Motor
- Motor con batería al litio



- OVO-LOCK
- OVO-LOCK
- OVO-LOCK
- OVO-LOCK

Roll-up - System 46

S46G

S46BP

S46N



S46G

S46BP

S46N

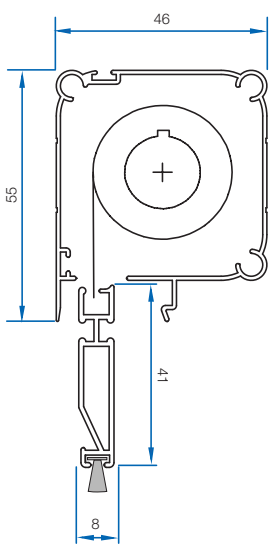
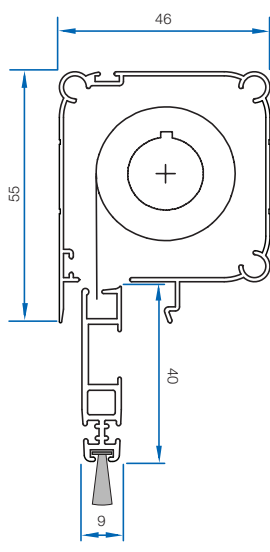
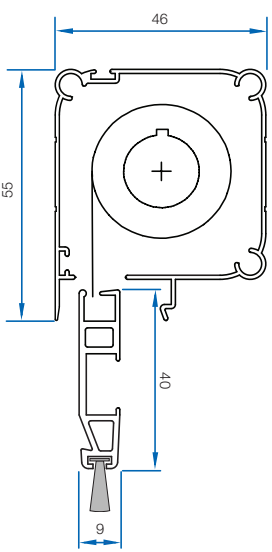

S46PRO

S46ZG

S46ZG-XL



S46PRO

S46ZG

S46ZG-XL

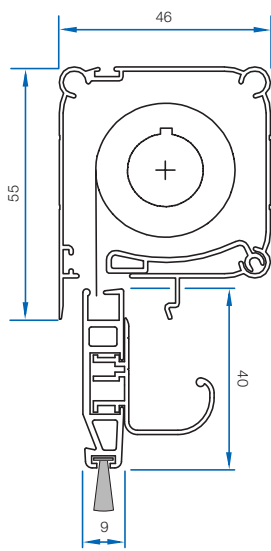
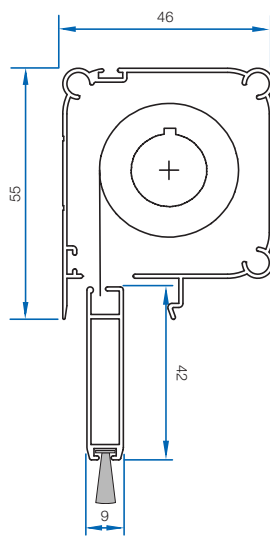
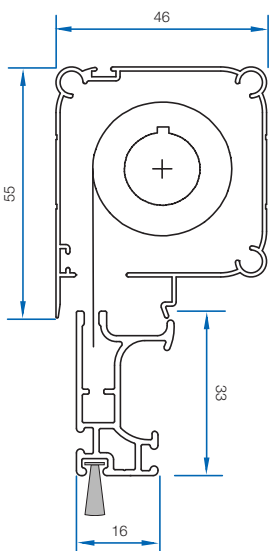

VERTICAL VERSION ONLY

CHAIN AND MOTORIZED VERSION ONLY

CHAIN EXTRA LARGE VERSION ONLY

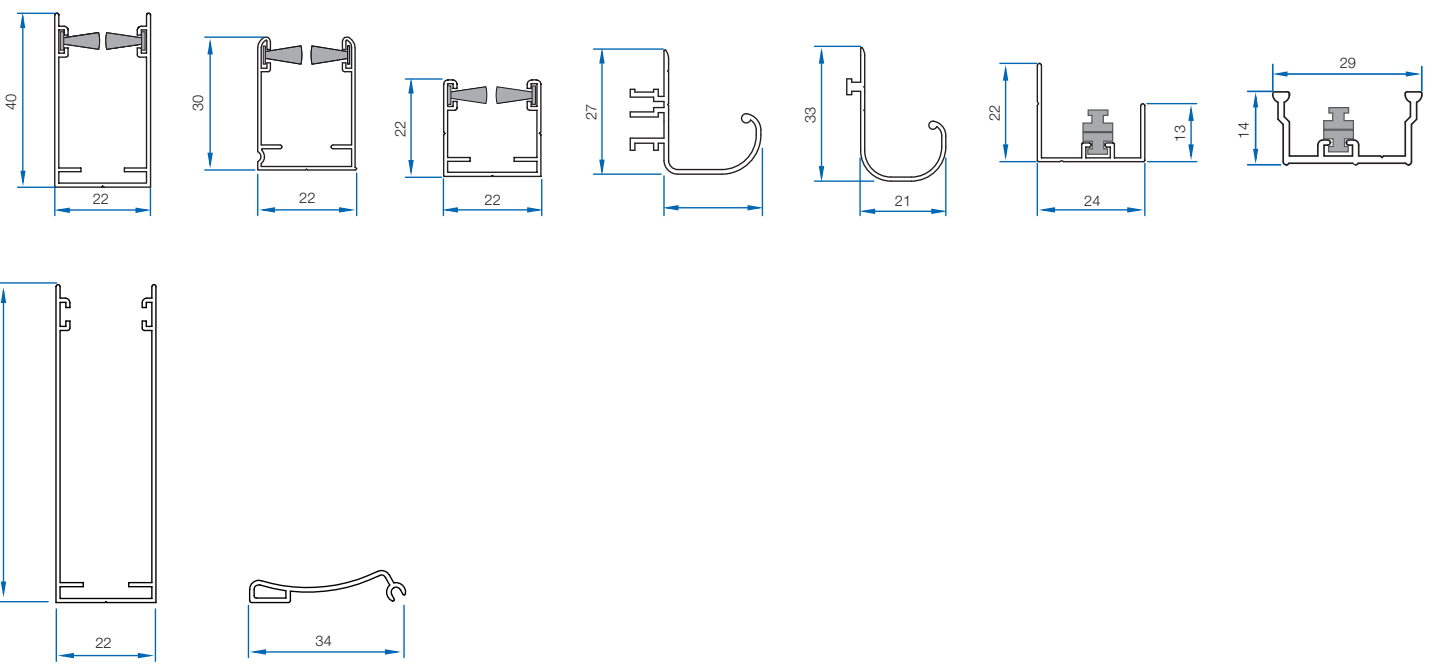

Max dimensions in mm

standard mesh fiberglass 18x16

| Vertical window | |
|-----------------|-----------|
| Width | 500/2000* |
| Height | 500/2600 |

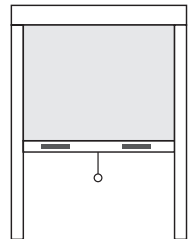

| Single roll-aside | |
|-------------------|-------------|
| Width | 400/1500 |
| Height | 1000/2600** |

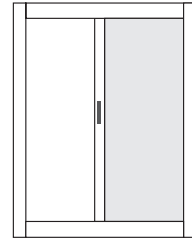

| ZG | |
|--------|----------|
| Width | 600/1800 |
| Height | 500/2600 |

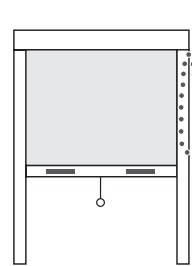

| Double roll-aside | |
|-------------------|-------------|
| Width | 1000/3000 |
| Height | 1000/2600** |

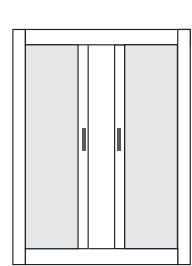

| ZG - XL | |
|---------|-----------|
| Width | 1800/5000 |
| Height | 500/2600 |

| Optional meshes available for S.46 | |
|------------------------------------|---------------------|
| Type | Max Height possible |
| High transparency mesh | 260 cm |
| High resistance mesh | 160 cm |
| 20x20 mesh | 183 cm |
| 20x30 mesh | 183 cm |
| Antipollen net | 220 cm |
| Solar shading Microscreen | 195 cm |
| Blackout Trigras | 195 cm |

OPTIONS

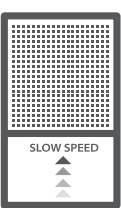

- Brake-Speed reducer
- Frein viscodynamique
- Desacelerador viscodinámico

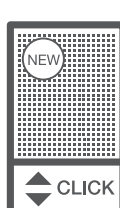

- Click-Stop
- Click-Stop
- Click-Stop



- Anti-Wind brushpile
- Brosse anti-vent
- Windschutzbürste
- Felpudo antiviento

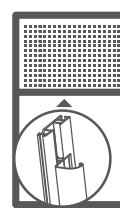

- Reinforcing profile
- Profil de renfort
- Verstärkungsprofil
- Perfil de refuerzo



- Lithium battery Motor
- Moteur Accu Lithium
- Lithium Motor
- Motor con batería al litio



- OVO-LOCK
- OVO-LOCK
- OVO-LOCK
- OVO-LOCK

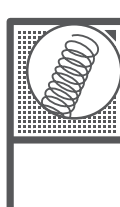

- STC spring tension control
- STC Réglage de la tension du ressort
- STC Federspannungskontrolle
- Control de tensión del muelle STC spring

Roll-up - System 41 Built-in

S41 BUILT-IN

S41 BUILT-IN ZG



S41 BUILT-IN

S41 BUILT-IN ZG

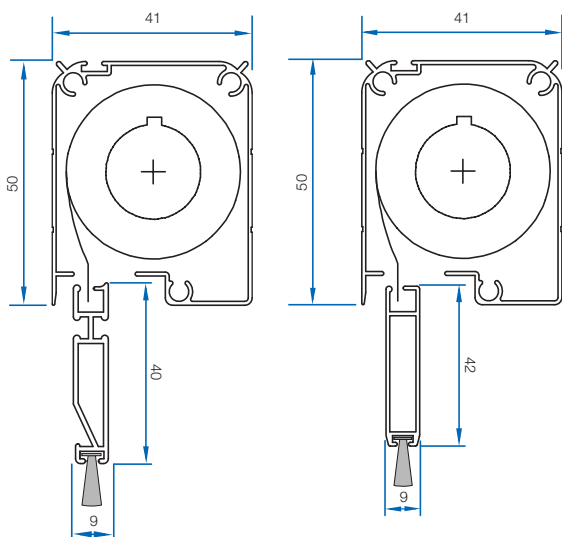

CHAIN VERSION ONLY

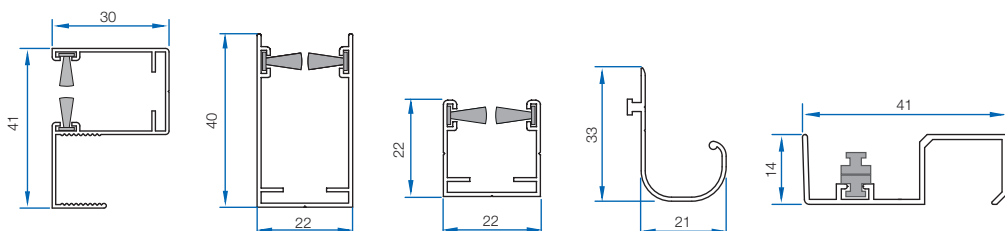

Max dimensions in mm

standard mesh fiberglass 18x16

Vertical window

| | |
|--------|-----------|
| Width | 500/2000* |
| Height | 500/2600 |

* 2300 with reinforcing profile added to pull-bar

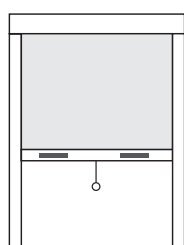

Single roll-aside

| | |
|--------|-------------|
| Width | 500/1500 |
| Height | 1000/2600** |

** 2900 with reinforcing profile added

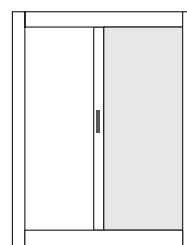

ZG

| | |
|--------|----------|
| Width | 600/1800 |
| Height | 500/2600 |

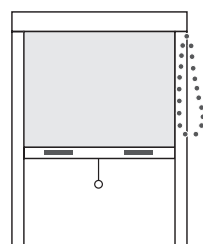

Double roll-aside

| | |
|--------|-------------|
| Width | 1000/3000 |
| Height | 1000/2600** |

** 2900 with reinforcing profile added



Optional meshes available for S.41 Built-in

| Type | Max Height possible |
|---------------------------|---------------------|
| High transparency mesh | 260 cm |
| High resistance mesh | 140 cm |
| 20x20 mesh | 170 cm |
| 20x30 mesh | 170 cm |
| Antipollen net | 220 cm |
| Solar shading Microscreen | 160 cm |
| Blackout Trigras | 160 cm |

OPTIONS

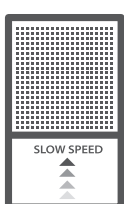

- Brake-Speed reducer
- Frein viscodynamique
- Bremse - Verlangsamter
- Desacelerador viscodinámico

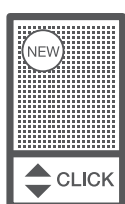

- Click-Stop
- Click-Stop
- Click-Stop
- Click-Stop

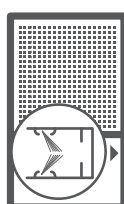

- Anti-Wind brushpile
- Brosse anti-vent
- Windschutzbürste
- Felpudo antiviento

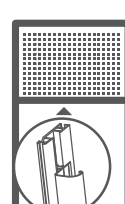

- Reinforcing profile
- Profil de renfort
- Verstärkungsprofile
- Perfil de refuerzo

Roll-up - System 46 Built-in

S46 BUILT-IN

S46 BUILT-IN ZG



S46 BUILT-IN

S46 BUILT-IN ZG

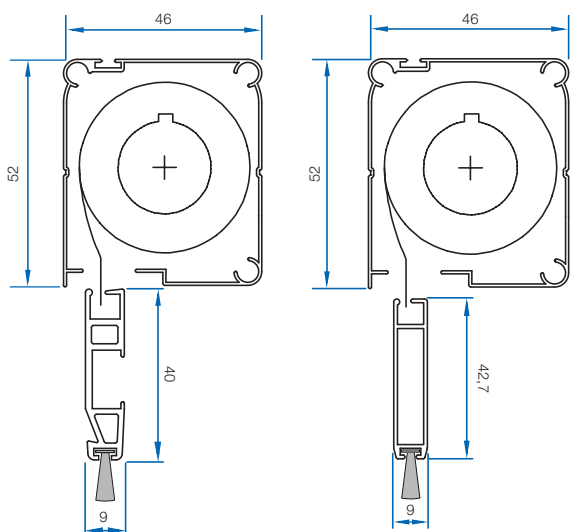

CHAIN VERSION ONLY

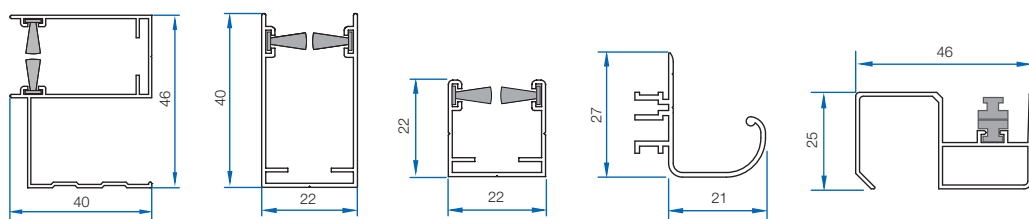

Max dimensions in mm

standard mesh fiberglass 18x16

Vertical window

| | |
|--------|-----------|
| Width | 500/2000* |
| Height | 500/2600 |

* 2300 with reinforcing profile added to pull-bar

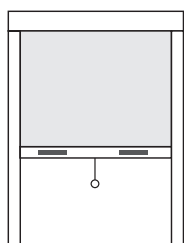

Single roll-aside

| | |
|--------|-------------|
| Width | 500/1500 |
| Height | 1000/2600** |

** 2900 with reinforcing profile added

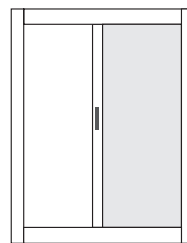

ZG

| | |
|--------|----------|
| Width | 600/1800 |
| Height | 500/2600 |

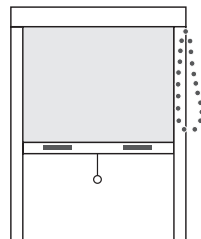

Double roll-aside

| | |
|--------|-------------|
| Width | 1000/3000 |
| Height | 1000/2600** |

** 2900 with reinforcing profile added



Optional meshes available for S.46 Built-in

| Type | Max Height possible |
|---------------------------|---------------------|
| High transparency mesh | 260 cm |
| High resistance mesh | 160 cm |
| 20x20 mesh | 183 cm |
| 20x30 mesh | 183 cm |
| Antipollen net | 220 cm |
| Solar shading Microscreen | 195 cm |
| Blackout Trigras | 195 cm |

OPTIONS

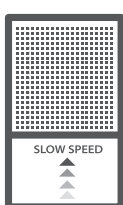

- Brake-Speed reducer
- Frein viscodynamique
- Bremse - Verlangsamer
- Desacelerador viscodinámico

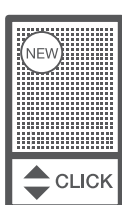

- Click-Stop
- Click-Stop
- Click-Stop
- Click-Stop



- Anti-Wind brushpile
- Brosse anti-vent
- Windschutzbürste
- Felpudo antiviento

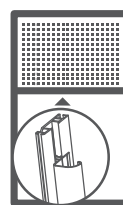

- Reinforcing profile
- Profil de renfort
- Verstärkungsprofile
- Perfil de refuerzo